



DOI: 10.22070/JQEPO.2022.16598.1242

## **The integrated order picking and delivery with overbooking and delivery-delay allowed strategies: mathematical model and heuristic approaches**

A. Mojaver Tabrizi<sup>1</sup>, Behnam Vahdani<sup>1\*</sup>, F. Etebari<sup>1</sup>, M. Amiri<sup>2</sup>

<sup>1</sup> Department of Industrial Engineering, Qazvin Branch, Islamic Azad University, Qazvin, Iran

<sup>2</sup> Department of Industrial Management, Allameh Tabataba'i University, Tehran, Iran

\* **Corresponding Author:** Behnam Vahdani (Email: [b.vahdani@gmail.com](mailto:b.vahdani@gmail.com))

---

**Abstract** – This paper considers the integrated order picking (joint order batching and picker routing) and delivery problem in a manual picker-to-parts and multi-block 3D warehouse with considering overbooking and delivery-delay allowed strategies. Received orders by the customers are grouped into the batches, assigned to the pickers with horizontal and vertical velocities to compute the travel time, picked up from the shelves of the warehouse, and delivered to customers' community. The warehouse's policy is to accept orders for a certain number of unavailable products in addition to the available products. Thus, the concept of the overbooking strategy for supplying unavailable products and the delivery postponed strategy for delayed delivery is applied. Hence, this study introduces a novel mathematical model to deal with such a system, where the objective aims to minimize the cost of the completion time of all batches, the purchasing of the unavailable products and the return time of all vehicles to the depot. To solve this model, four new heuristic algorithms are devised, a broad range of numerical experiments is investigated to illustrate the validity and applicability of the proposed model and solution approaches.

**Keywords**– Integrated order picking and delivery; Joint order batching and picker routing; Overbooking; Deliver-delay allowed; Heuristics

---

### **I. INTRODUCTION**

Order picking as a critical planning operation is the retrieval of requested products from storage locations to fulfill order requests. Manual order picking systems are usually divided into two groups: picker-to-parts systems and parts-to-picker systems. In a picker-to-parts system, order pickers walk and ride through the warehouse to retrieve the required products. In parts-to-picker systems, automated storage and retrieval systems (AS/RS) pick up required products from the warehouse and deliver them at a pickers' fixed station. It should be noted that the current research is focused on the picker-to-parts systems. In a picker-to-parts order picking system, two operational planning problems can be considered: 1) order batching, which means grouping orders to picking orders (batches); and 2) picker routing, which means determining a sequence for collecting the required products of each picking order (Henn, 2012). In the warehouse literature, the two problems of the order batching problem and the picker routing problem have been vastly studied as two separate problems while, these two problems are interdependent strongly (Van Gils et al., 2019). The picker routing

problem can be solved that the outcome of the order batching problem is known. Also, the order batching problem cannot be solved without knowing the routing strategy, i.e., how the pickers can walk through the warehouse (Aerts et al., 2021). It is essential for order picking systems to consider a joint order batching and picker routing problems efficiently to achieve effective performance in picking operation. The researches on the joint order batching and picker routing problems can be found in the warehouse literature since 2005. This study focuses on supplying two types of available and unavailable products in the warehouse. Therefore, the overbooking strategy is applied to buy the unavailable products. In addition, due to the unavailable products have delay in the delivery process, the delivery-delay allowed strategy is used. To the best of our knowledge, there is a research gap regarding mathematical modeling of a joint order batching and picker routing problems with the delivery process with two mentioned strategies in order picking systems.

Subsequently, a novel mathematical model is proposed to formulate order picking and delivery problem with considering two mentioned strategies, where the objective function minimizes cost of the completion time of all batches, the purchasing of the unavailable products and the return time of all vehicles to the depot. Duo to the complexity of the problem and achieving high-quality solutions within a reasonable time, four new heuristic algorithms are devised. Hence, the main contributions of the current study to the literature are listed as follows:

- Considering order picking (order batching and picker routing problems) with multi pickers, scanning-packing orders in depot, two types of products and delivery problem in a novel integrated model.
- Regarding a multi-block 3D warehouse with pickers' horizontal and vertical velocities.
- Considering overbooking and delivery-delay allowed strategies.
- Proposing four new heuristic algorithms for solving the proposed model.

The remainder of this paper is organized as follows. Section 2 offers an overview of the related literature. In section 3, the problem definition and formulation are described. Section 4 contains the description of the new heuristic algorithms. Computational experiments and sensitivity analysis are reported in section 5. Finally, the conducting remarks and some directions for future research are given in section 6.

## II. LITERATURE REVIEW

In this section, we review the literature in the relevant areas of order batching, picker routing, joint order batching and picker routing problems.

Won and Olafsson (2005) presented a mathematical model for the two simultaneous problems of order batching and picker routing. The goal of the model was to minimize the total traveled distances by all batches and the order holding time. They presented two heuristic algorithms to solve the model. In the first algorithm, the batching of the orders was specified, and in the second algorithm, picking and picker routing were determined. But in this research, the three-dimensional space of the warehouse and the delivery process are not considered. Henn et al. (2012) conducted a comprehensive research on the problem of order batching in the order picking system. The manual order picking systems, picker-to-parts systems, were investigated in both offline and online environments. Different characteristics and conditions of the order batching problem were proposed and several approaches were presented to solve the above problems. Kulak et al. (2012) presented a programming model for order batching and picker routing problems simultaneously. This model minimized the total traveled distances by all batches. They proposed a tabu search heuristic algorithm based on a similarity-regret value index (RS\_RV). This means that if the orders are merged, the overlap is defined in the travel distances. Also, two heuristic algorithms were used for picker routing problem. But, the three-dimensional space of the shelves and the delivery process are not regarded. Valle et al. (2017) proposed a mixed integer programming model for order batching and picker routing problems. The purpose of the model was to determine the shortest route between the requested locations. The arrangement of the warehouse was considered as multi-block. An

exact solution approach was presented to solve the above two simultaneous problems. But the set of pickers and the three-dimensional space of the shelves in the warehouse have not been considered. Also, the horizontal and vertical velocities for the pickers and the delivery process are not regarded. Scholz et al. (2017) presented a mathematical model for order batching and picker routing problems. Each order had a due date and the purpose of the model was to minimize the total order delivery delay. A heuristic algorithm was presented to solve the model simultaneously. They proposed a heuristic approach to generate the initial solution and a variable neighborhood search approach to solve the problem. But the assumptions related to the pickers' velocities and the order delivery process have not been regarded. Jiang et al. (2018) presented a mathematical model for the order batching and sequencing problem, which was an extension of the order batching problem. The purpose of the model was to determine the batching and sequencing orders in online supermarkets so that the total completion time of the picking and sorting-packing processes was minimized. The presented model was solved by a developed heuristic seed algorithm. But they did not consider the set of pickers for assigning, picking and routing of the batches. Also, the process of delivery to the customers is not regarded. Pansart et al. (2018) presented an optimization model for picker routing problem, and two exact algorithms were developed and presented to solve the above model. However, the order batching, the set of pickers, the characteristics related to the pickers and travel time between the slots of the shelves in the three-dimensional warehouse have not been considered. Also, the simultaneous and integrated delivery process is not regarded. Weidinger (2018) rendered a model for picker routing problem based on the scattered storage strategy so that the total traveled distance was minimized. The model was solved by heuristic algorithms with low computational complexity. But in the mentioned model, none of assumptions related to the order batching, the pickers' characteristics and the delivery process are considered. Weidinger et al. (2019) presented a mathematical model for picker routing problem in a warehouse with mixed shelves. The allocation of the products was based on the scattered strategy, and each unit of the products was placed in several different places in the warehouse with a small number. The goal of the model was to determine the total traveled distance. Three heuristic algorithms and one improved heuristic algorithm were used to solve the model. However, the order batching, set of pickers, the pickers' velocities and the process of delivery orders to the customers have not been considered. Van Gils et al. (2019) investigated the problems of order picking, picker routing and picker scheduling and presented a mathematical model simultaneously. The goal of the model was to minimize the completion time of all batches by all pickers. A local search algorithm was presented, which included heuristic algorithms for creating initial solution, routing and picker scheduling, and perturbation. But the integrated process of order delivery to customers along with order picking is not considered. Wang et al. (2019) presented three mathematical models for the problem of shipping cargo by considering two strategies of overbooking and delivery-delay allowed. They stated that there was always a gap between recorded order amount and the actual order amount. The amount of this gap or the value of conversion rate can affect the income of the shipping companies. The goal of the first model was to maximize revenue. In the second model, the overbooking strategy was used, and the goal of this model was to maximize profit. In the third model, in addition to the first strategy, delivery-delay allowed strategy was also used. The cargoes were divided into two groups, sensitive and insensitive. As a result, by considering some cargoes with postponed delivery, the amount of resulting penalty from the first strategy was minimized by the second strategy. Also, they presented a heuristic approach to solve this model. Briant et al. (2020) investigated the problems of the order batching and picker routing and presented a column generation based heuristic algorithm. Also, an exponential linear programming formulation was presented so that the variables or columns were related to the picking paths in the warehouse. But the process of delivery is not included. Cano et al. (2020) presented two mathematical models due to the importance of simultaneous considering the two problems of order batching and picker routing. In order to model the picker routing problem, relations for distances and travel time between the shelves of the warehouse were rendered. Also, two other mixed integer models were presented. The purpose of the models was how to minimize the total delay by considering the due dates of the orders based on time windows. The solution approach for the mentioned models was not provided. They also did not consider the delivery process. Masae et al. (2020) studied the picker routing problem in manual order picking systems. Also, the extent of using three general methods of exact, heuristic and metaheuristic solution approaches for this problem was stated. Aerts et al. (2021) presented a cluster-based model for the order batching and picker routing problems simultaneously. The goal of the model was to minimize the total travel distance of all batches. Three heuristic algorithms for assigning orders to the batches were described and finally, a metaheuristic two-level variable neighborhood search algorithm was rendered to solve two problems simultaneously. But the integrated process of picking and delivery has not

been regarded.

To improve efficiency and reduce supply chain costs, a green supply chain design was modeled as a multi-objective programming model by Jamshidi et al. (2012) to minimize the total cost of the supply chain. A memetic algorithm with Taguchi method were applied to solve the proposed model. Considering closed-loop supply chain network design, Boronoos et al. (2019) proposed a mathematical model to minimize the total cost of the multi-echelon network and maximize the responsiveness in two directions. They utilized an augmented  $\epsilon$ -constraint approach to solve the model. Agahgolnezhad et al. (2021) presented a bi-objective mathematical model with perishable products to delivery customers' demands. The aim of this model was to minimize the total cost and the total amount of emmissions at all levels of the network. In another study by Kalantari Khalil Abad et al. (2020), a three-objective mathematical model was presented for green closed-loop supply chain. The chance-constraint and a random cost function approach were applied to define some deterministict parameters. For solving the model, the goal attainment and GAMS software were utilized. In addition, Rabbani et al. (2020) presented a novel multi-period mathematical model for bioenergy supply chain to minimize the total costs of the network and vehicle routing. Also, NSGA-II algorithm was utilized to solve the proposed model. Keshmiry Zadeh et al. (2021) stated that disruption in products distribution had an important factor in supply chain management and planning. They proposed a multi-objective mathematical programming for green closed-loop supply chain to minimize the total cost and the total amount of emmissions. Gitinavard et al. (2019) presented a new evaluation approach based on fuzzy set environment. A bi-objective multi-echelon supply chain mathematical model was proposed. This approach aimed to rank the obtained pareto optimal points from the presented model. Gitinavard et al. (2020) offered a dynamic hesitant fuzzy consensus method to access sustainable feedstock. Also, a revised multi-choice goal programming is extended for renewable product allocation. Vakili et al. (2021) presented a green open location routing stochastic model with pickup and delivery to minimize the total costs of this system. Gitinavard et al. (2021) presented a possibilistic programming approach to estimate the hesitant fuzzy membership function. Based on this approach, a mathematical model was proposed to minimize the sum of squared errors between the total data.

According to the literature, no model for a joint online order batching and picker routing problem in a multi-picker-to-parts system within a 3D warehouse has been offered in which the considerations of two types of available and unavailable products, scanning-packing orders in depot, applying two strategies of overbooking and delivery postponed, and order delivery to the customers as an integrated order picking and delivery process have been reflected.

Table I. A brief literature review

| Authors and year        | Order batching | Batching and sequencing | Picker routing |               |          |                                  |                      | Order delivery | Overbooking and delivery postponed strategy1 | Solution method         |                |           |       |
|-------------------------|----------------|-------------------------|----------------|---------------|----------|----------------------------------|----------------------|----------------|--|-------------------------|----------------|-----------|-------|
|                         |                |                         | Single picker  | Multi-pickers | Modeling | Horizontal and vertical velocity | Warehouse dimensions |                |  | Commercial solver/Exact | Meta-heuristic | Heuristic |       |
|                         |                |                         |                |               |          |                                  | two                  |                |  |                         |                |           | three |
| Won and Olafsson (2005) | ✓              |                         | ✓              |               | ✓        |                                  | ✓                    |                |  |                         |                | ✓         |       |
| Kulak et al. (2012)     | ✓              |                         | ✓              |               | ✓        |                                  |                      |                |  |                         |                |           | ✓     |
| Valle et al. (2017)     | ✓              |                         |                |               | ✓        |                                  |                      |                | ✓  |                         |                |           |       |
| Scholz et al. (2017)    | ✓              |                         | ✓              |               | ✓        |                                  |                      |                |  |                         | ✓              |           | ✓     |

|                          |   |   |   |   |   |   |   |   |   |   |
|--------------------------|---|---|---|---|---|---|---|---|---|---|
| Jiang et al. (2018)      | ✓ |   |   |   |   |   |   |   |   | ✓ |
| Pansart et al. (2018)    |   |   | ✓ |   |   |   |   | ✓ |   |   |
| Weiding er (2018)        |   |   | ✓ |   |   |   |   |   |   | ✓ |
| Weiding er et al. (2019) |   |   | ✓ |   |   |   |   |   |   | ✓ |
| Van Gils et al. (2019)   | ✓ |   | ✓ | ✓ |   |   |   |   | ✓ | ✓ |
| Wang et al. (2019)       |   |   |   |   |   |   | ✓ |   |   | ✓ |
| Briant et al. (2020)     | ✓ |   |   | ✓ |   |   |   |   |   | ✓ |
| Cano et al. (2020)       | ✓ | ✓ | ✓ | ✓ | ✓ | ✓ |   |   |   |   |
| Aerts et al. (2021)      | ✓ |   |   | ✓ |   |   |   |   | ✓ | ✓ |
| Current research         | ✓ |   | ✓ | ✓ | ✓ | ✓ | ✓ | ✓ |   | ✓ |

### A. Research gap

This paper, different from the above studies, considers integrated order picking (joint order batching and picker routing) and delivery in a manual order picking system. Multi pickers are regarded to pick up orders from the slots of the shelves. There is a multi-layer warehouse in the form of a three-dimensional with various shelves with known capacity. Also, the travel time with considering the pickers' horizontal and vertical velocities in this multi-block 3D warehouse can be calculated between each two slots. The warehouse policy regards to accept the orders which include unavailable products in addition to the available products. For this purpose, total products are divided into two types of products: unavailable and available. Thus, the concept of the overbooking strategy for purchasing the unavailable products and the delivery-delay allowed strategy for delayed deliveries are applied. According to these conditions, the orders are divided into two parts. Each customer' order has at least one unavailable product. Thus, each order is definitely divided into two parts. In this study, it is assumed that the delivery to each customer will be done in two times at most. Split orders must be identified (scanned) and packed during the consolidation process at the depot. Therefore, for each order, two packages are packed for delivery: unavailable products and available products. Finally, for such an order picking system, a novel mathematical model is proposed to minimize the cost of the completion time of all batches, the purchasing of the unavailable products and the return time of all vehicles to the depot.

### III. PROBLEM DEFINITION

This research studies the two processes of picking orders in the warehouse and delivering orders to customer community in an order receiving environment. This system involves a multi-layer warehouse in the form of a three-

dimensional warehouse that has numerous shelves with known capacities, each separated into two slots. There are horizontal and vertical aisles between the shelves facilitating the pickers' mobility. In addition, three levels are expected for all shelves, and one depot is planned for the pickers' arrival and departure. Pickers can go down all of the aisles in the warehouse to find the products they need. Fig. 1 depicts the structure of the investigated subject. The mentioned system intends to supply a certain number of unavailable products. For this purpose, it has a plan to buy unavailable products from a certain number of sellers. Therefore, the total number of the presented products in the system is divided into two parts: available products and unavailable products. Orders are batches after arriving into the system. Each order is divided into two parts if there are two types of products. For each order, it is not necessary to put all other products of that order in the same batch. In the delivery process to the customer community, the scanning and packing times are considered for each product of each order in the depot. After order batching, the batches are picked from the shelves by the pickers. Duo to the orders are divided into unavailable and available products, and are delivered to customer community in two steps, the total number of batches is divided into two parts. The unavailable products are supplied from specific sellers, and their number, location, and the round-trip time from depot to their vendors are known. Also, the total number of each type of unavailable products in all orders is known based on their information of the arrival times. Therefore, to provide the unavailable products and also to have these products in the warehouse, the overbooking strategy is used. This means that more than the required number of these types of products, the purchasing process is done. In order to deliver orders to customer community, the vehicles are divided into two parts. Therefore, because unavailable products have delay in the delivery process, the delivery-delay allowed strategy is used. The first and the second parts of the vehicles are considered for the delivery of the unavailable and available products, respectively. The space of the warehouse is three-dimensional, and three layers are considered for the shelves. Thus, the structure of the multi-block 3D warehouse is regarded for this study. To calculate travel time in 3D warehouse (multilayered warehouse), let  $\mathcal{B}$  denotes the set of blocks, where  $\mathcal{B} \in \mathcal{B}$ . In this regard,  $\mathbb{U}_{\mathcal{B}}$  and  $\mathbb{D}_{\mathcal{B}}$  represent the y-coordinates of the upper and lower end of block  $\mathcal{B}$ , respectively. Travel time in three dimensions depends on the simultaneity of the horizontal, and vertical movements, where horizontal movements are on the x-axis and the y-axis and vertical movements are on the z-axis. Thus, the pickers' horizontal and vertical velocity should be regarded and denoted by  $v_h$  and  $v_v$ . Eq. (1) calculates travel time between slots  $i$  and  $j$ . If two slots belong to the same aisle, the first term of Eq. (1) calculates the maximum time between horizontal and vertical movements based on Tchebychev metrics. Otherwise, for two slots belonging to different aisles, the minimum time required for changing the aisle by walking one of the top or bottom cross aisle is calculated by the second term of Eq. (1). In this regard, an example of the configuration of a two-block 3D warehouse between two slots belonging to different aisles is shown in Fig 2. For this example, the points  $(0, \mathbb{U}_2, 0)$  and  $(0, \mathbb{D}_2, 0)$  are considered as the top and bottom coordinates for block 2, and two points  $(0, \mathbb{U}_1, 0)$  and  $(0, \mathbb{D}_1, 0)$  are the top and bottom coordinates for block 1. Two slots  $i$  and  $j$  can be shown as  $i = (x_{i2}, y_{i2}, z_{i2})$  and  $j = (x_{j1}, y_{j1}, z_{j1})$ .

$$t_{ij} = \left\{ \begin{array}{ll} \max \left\{ \frac{|x_i - x_j| + |y_i - y_j|}{v_h}, \frac{|z_i - z_j|}{v_v} \right\} & \text{if } i \text{ and } j \text{ belong to the same aisle} \\ \min \left\{ \max \left\{ \frac{|y_i - \mathbb{U}| + |x_i - x_j| + |\mathbb{U} - y_j|}{v_h}, \frac{|z_i - z_j|}{v_v} \right\}, \max \left\{ \frac{|y_i - \mathbb{D}| + |x_i - x_j| + |\mathbb{D} - y_j|}{v_h}, \frac{|z_i - z_j|}{v_v} \right\} \right\} & \text{otherwise} \end{array} \right\} \quad (1)$$

for  $0 \leq i \neq j \leq \mathcal{M}$

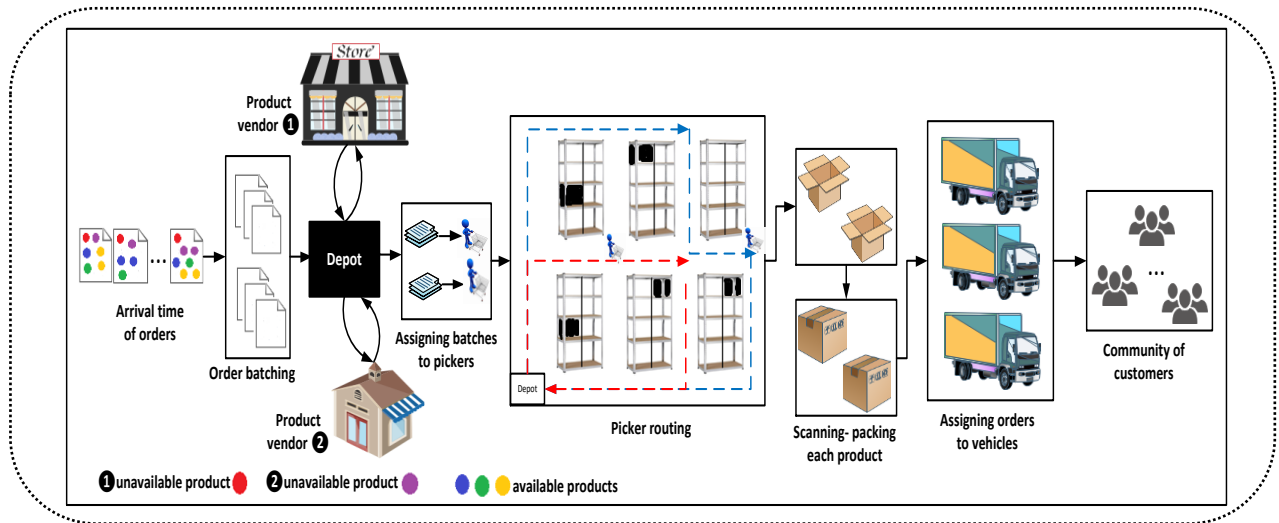

Fig 1. The graphic framework of the investigated problem.

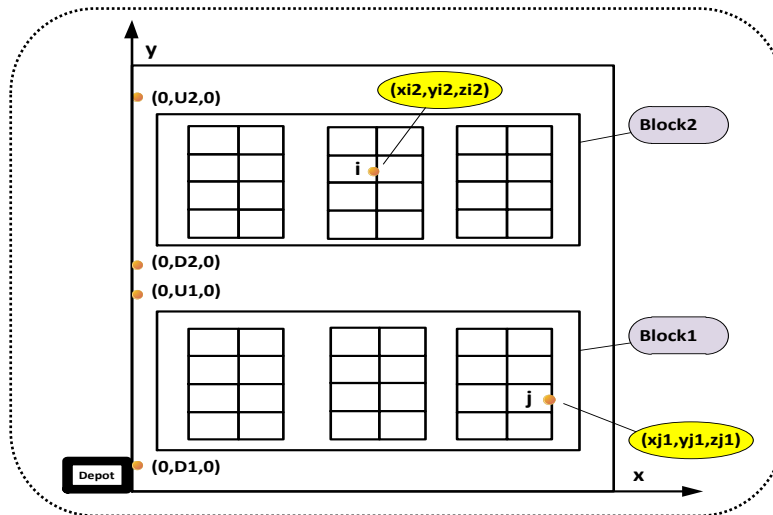

Fig 2. The structure of the multi-block 3D warehouse.

The following assumptions are considered to formulate this problem:

- There is at least one unavailable product per customer' order.
- Each order is definitely divided into two parts.
- All products include unavailable products and available products.
- The consolidation process in the depot must be done for all products.
- For each customer, there are two packages for delivery, which include unavailable products and available products.
- Delivery to each customer is made in two times at most.

**B. Sets and indices**

---

|              |   |
|--------------|---|
| $S$          | Set of slots of the shelves indexed by $i, j, l$ {depot: 0; slots : 1, ..., $S$ } |
| $O$          | Set of orders indexed by $o$  |
| $U$          | Set of the unavailable products of the orders                                     |
| $A$          | Set of the available products of the orders                                       |
| $\mathbb{P}$ | Set of all products with $\mathbb{P} = U \cup A$ indexed by $p$                   |
| $\Gamma$     | Set of batches for the set of products $U$ of the orders                          |
| $\Phi$       | Set of batches for the set of products $A$ of the orders                          |
| $\mathbb{B}$ | Set of all batches with $\mathbb{B} = \Gamma \cup \Phi$ indexed by $b$            |
| $P$          | Set of pickers $p$  |
| $\Lambda$    | Set of vehicles for delivery the set of products $U$ to customers                 |
| $\Delta$     | Set of vehicles for delivery the set of products $A$ to customers                 |
| $\mathbb{V}$ | Set of all vehicles with $\mathbb{V} = \Lambda \cup \Delta$ indexed by $v$        |

---

**C. Parameters**

---

|                 |   |
|-----------------|---|
| $c_b$           | Maximal number of the products in batch $b$   |
| $t_o$           | Arrival time of order $o$ , where $0 \leq t_o \leq t_{o+1}$ and $1 \leq o \leq O - 1$ |
| $a_{po}$        | 1 if product $p$ is in order $o$ ; 0 otherwise  |
| $r_{ip}$        | 1 if slot $i$ is considered for product $p$ ; 0 otherwise                             |
| $\bar{t}_{bp}$  | Setup time of batch $b$ by picker $p$   |
| $d_{ij}$        | Distance between slots $i$ and $j$  |
| $v_h$           | Pickers' horizontal velocity  |
| $v_v$           | Pickers' vertical velocity  |
| $t_{ij}$        | Travel time between slots $i$ and $j$   |
| $\mathcal{R}_p$ | Round-trip time from depot to product vendor location $p(p \in U)$                    |
| $\mathcal{C}_p$ | Consumed time at product location $p(p \in U)$  |
| $n_{po}$        | Number of product $p$ of order $o$  |
| $p_o$           | Total number of products $p(p \in U)$ in order $o$ ; $\sum_{p \in U} n_{po}$          |
| $q_o$           | Total number of products $p(p \in A)$ in order $o$ ; $\sum_{p \in A} n_{po}$          |
| $s_p$           | Total number of product $p(p \in U)$ through all orders                               |
| $\mathcal{O}_p$ | The overbooking percentage for purchasing product $p(p \in U)$                        |
| $\mathcal{N}_p$ | Allowed number of product $p(p \in U)$ on its shelf                                   |
| $\mathcal{M}_p$ | Allowed number of product $p(p \in U)$ in the warehouse                               |
| $t_1$           | The scanning time of each product   |
| $t_2$           | The packing time of each product  |
| $\mathcal{C}_v$ | Capacity of vehicle $v$   |
| $\mathcal{Z}_p$ | Purchase price per unit product $p(p \in U)$  |
| $t$             | Round trip-time from depot to the community of customers                              |
| $\infty_i$      | Required search and pick time for slot $i$  |
| $w_1$           | Completion cost per each pickup   |
| $w_2$           | Return cost per each delivery   |

---



**D. Decision variables**

---

|                             |  |
|-----------------------------|--|
| $x_{ij}^b$                  | 1 if slot $j$ is visited immediately after slot $i$ by batch $b$ in pickup process ; 0 otherwise |
| $\psi_{ob}^p$               | 1 if product $p$ of order $o$ is assigned to batch $b$ ; 0 otherwise                             |
| $z_{bp}$                    | 1 if batch $b$ is assigned to picker $p$ ; 0 otherwise   |
| $\sigma_{bi}$               | 1 if slot $i$ is visited by batch $b$ ; 0 otherwise  |
| $w_i^b$                     | Position slot $i$ in routing batch $b$   |
| $\Theta_{bp}$               | Start time of batch $b$ by picker $p$  |
| $\mathfrak{X}_{bp}$         | Travel time of batch $b$ by picker $p$   |
| $\mathbb{S}\mathbb{P}_{bp}$ | Pick time of batch $b$ by picker $p$   |
| $\mathfrak{f}_{bp}$         | Service time of batch $b$ by picker $p$  |
| $\mathbb{C}_{bp}$           | Completion time of batch $b$ by picker $p$   |
| $Q_p$                       | Quantity purchased of product $p$ ( $p \in U$ )  |
| $\mathbb{H}1_o$             | The number of unavailable products of order $o$  |
| $\mathbb{H}2_o$             | The number of available products of order $o$  |
| $\Psi_o$                    | The scanning-packing time of order $o$ contains unavailable products                             |
| $\Omega_o$                  | The scanning-packing time of order $o$ contains available products                               |
| $\mathfrak{f}_{ov}$         | 1 if order $o$ is assigned to vehicle $v$ ; 0 otherwise  |
| $\mathcal{D}_v$             | Departure time of vehicle $v$ from depot   |
| $\mathbb{R}_v$              | Return time of vehicle $v$ to depot  |

---

**E. Mathematical model**

$$\min z = w_1 \sum_{b \in \mathbb{B}} \sum_{p \in P} \mathbb{C}_{bp} + \sum_{p \in U} \mathfrak{Z}_p Q_p + w_2 \sum_{v \in V} \mathbb{R}_v \tag{2}$$

s. t.

$$\sum_{b=1}^{\Gamma} \psi_{ob}^p = a_{po} \quad \forall p \in U; o \in O \tag{3}$$

$$\sum_{b=1}^{\Phi} \psi_{ob}^p = a_{po} \quad \forall p \in A; o \in O \tag{4}$$

$$\sum_{p=1}^U \sum_{o=1}^O n_{po} \psi_{ob}^p \leq c_b \quad \forall b \in \Gamma \tag{5}$$

$$\sum_{p=1}^A \sum_{o=1}^O n_{po} \psi_{ob}^p \leq c_b \quad \forall b \in \Phi \tag{6}$$

$$\sum_{p=1}^P z_{bp} = 1 \quad \forall b \in \Gamma \tag{7}$$

$$\sum_{p=1}^P z_{bp} = 1 \quad \forall b \in \Phi \tag{8}$$

$$\sigma_{bi} \geq a_{po} \psi_{ob}^p r_{ip} \quad \forall i \in S; o \in O; b \in \Gamma; p \in U \tag{9}$$

$$\sigma_{bi} \geq a_{po} \psi_{ob}^p r_{ip} \quad \forall i \in S; o \in O; b \in \Phi; p \in A \tag{10}$$

$$\sum_{i=0}^S x_{ij}^b = \sigma_{bj} \quad \forall j \in S; b \in \Gamma \tag{11}$$

$$\sum_{j=0}^S x_{ij}^b = \sigma_{bi} \quad \forall i \in S; b \in \Gamma \tag{12}$$

$$\sum_{i=0}^S x_{ij}^b - \sum_{l=0}^S x_{jl}^b = 0 \quad \forall b \in \Gamma; j \in S \tag{13}$$

$$\sigma_{bi} \leq \sum_{j=0}^S x_{ij}^b \quad \forall b \in \Gamma; i \in \mathcal{M} \tag{14}$$

$$Q_p \geq s_p(1 + \Delta_p) \quad \forall p \in U \quad (15)$$

$$Q_p \leq \mathfrak{N}_p + \mathfrak{M}_p \quad \forall p \in U \quad (16)$$

$$\sum_{i=0}^S x_{ij}^b = \sigma_{bj} \quad \forall j \in S; b \in \Phi \quad (17)$$

$$\sum_{j=0}^S x_{ij}^b = \sigma_{bi} \quad \forall i \in S; b \in \Phi \quad (18)$$

$$\sum_{i=0}^M x_{ij}^b - \sum_{h=0}^M x_{hl}^b = 0 \quad \forall b \in \Phi; j \in S \quad (19)$$

$$\sigma_{bi} \leq \sum_{j=0}^S x_{ij}^b \quad \forall b \in \Phi; i \in S \quad (20)$$

$$z_{bp} \leq \sum_{o=1}^O \sum_{p=1}^U \psi_{ob}^p \quad \forall b \in \Gamma; p \in P \quad (21)$$

$$z_{bp} \leq \sum_{o=1}^O \sum_{p=1}^A \psi_{ob}^p \quad \forall b \in \Phi; p \in P \quad (22)$$

$$\mathfrak{G}_{bp} \geq \max_{o \in O, p \in U} \{t_o \psi_{ob}^p\} + \sum_{p=1}^U \sum_{o=1}^O (\mathcal{R}_p + \mathcal{C}_p) \psi_{ob}^p \quad \forall b \in \Gamma; p \in P \quad (23)$$

$$\mathfrak{G}_{bp} \geq \max_{o \in O, p \in A} \{t_o \psi_{ob}^p\} \quad \forall b \in \Phi; p \in P \quad (24)$$

$$\mathfrak{I}_{bp} \geq \sum_{i=0}^S \sum_{j=0}^S t_{ij} x_{ij}^b z_{bp} \quad \forall b \in \mathbb{B}; p \in P \quad (25)$$

$$\mathbb{S}\mathbb{P}_{bp} = \sum_{i=1}^S \infty_i \sigma_{bi} z_{bp} \quad \forall b \in \mathbb{B}; p \in P \quad (26)$$

$$\mathfrak{f}_{bp} = (\overline{t}_{bp} + \mathfrak{I}_{bp} + \mathbb{S}\mathbb{P}_{bp}) z_{bp} \quad \forall b \in \mathbb{B}; p \in P \quad (27)$$

$$\mathfrak{C}_{bp} = (\mathfrak{G}_{bp} + \mathfrak{f}_{bp}) z_{bp} \quad \forall b \in \mathbb{B}; p \in P \quad (28)$$

$$w_i^b - w_j^b + |l| x_{ij}^b \leq |l| - 1 \quad \forall i, j \in S \setminus \{0\}, i \neq j; l \in S; b \in \Gamma \quad (29)$$

$$x_{ij}^b = 0 \quad \forall i, j \in S \setminus \{0\}, i = j; b \in \Gamma \quad (30)$$

$$w_i^b - w_j^b + |l| x_{ij}^b \leq |l| - 1 \quad \forall i, j \in S \setminus \{0\}, i \neq j; l \in S; b \in \Phi \quad (31)$$

$$x_{ij}^b = 0 \quad \forall i, j \in S \setminus \{0\}, i = j; b \in \Phi \quad (32)$$

$$\mathbb{H}1_o = \sum_{p=1}^U \sum_{b=1}^{\Gamma} \psi_{ob}^p p_o \quad \forall o \in O \quad (33)$$

$$\mathbb{H}2_o = \sum_{p=1}^A \sum_{b=1}^{\Phi} \psi_{ob}^p q_o \quad \forall o \in O \quad (34)$$

$$\Psi_o = \mathbb{H}1_o(t_1 + t_2) \quad \forall o \quad (35)$$

$$\Omega_o = \mathbb{H}2_o(t_1 + t_2) \quad \forall o \quad (36)$$

$$\sum_{v=1}^{\Lambda} f_{ov} = 1 \quad \forall o \in O \quad (37)$$

$$\sum_{o=1}^O p_o f_{ov} \leq \mathbb{C}_v \quad \forall v \in \Delta \quad (38)$$

$$\sum_{v=1}^{\Lambda} f_{ov} = 1 \quad \forall o \in O \quad (39)$$

$$\sum_{o=1}^O q_o f_{ov} \leq \mathbb{C}_v \quad \forall v \in \Delta \quad (40)$$

$$\mathcal{D}_v = \left( \max_{b \in \Gamma, p \in P} \{ \mathcal{C}_{bp} \} + \sum_{o=1}^O \mathcal{f}_{ov} \Psi_o \right) \quad \forall v \in \Lambda \quad (41)$$

$$\mathcal{D}_v = \left( \max_{b \in \Phi, p \in P} \{ \mathcal{C}_{bp} \} + \sum_{o=1}^O \mathcal{f}_{ov} \Omega_o \right) \quad \forall v \in \Delta \quad (42)$$

$$\mathbb{R}_v = \mathcal{D}_v + t \quad \forall v \in \Lambda \quad (43)$$

$$\mathbb{R}_v = \mathcal{D}_v + t \quad \forall v \in \Delta \quad (44)$$

$$x_{ij}^b, \mathcal{Y}_{ob}^p, z_{bp}, \sigma_{bi}, \mathcal{f}_{ov} \in \{0,1\}, \mathcal{S}_{bp}, \mathbb{S}\mathbb{P}_{bp}, \mathcal{I}_{bp}, \mathcal{I}_{bp}, \mathcal{C}_{bp}, \mathcal{D}_v, \mathbb{R}_v, \Psi_o, \Omega_o \geq 0, \omega_i^b, \mathcal{Q}_p, \mathbb{H}1_o, \mathbb{H}2_o \in Z \quad \forall b, i, j, p, o, v, p, v \quad (45)$$

The objective function (2) minimizes the cost of the completion time of all batches, the purchasing of the unavailable products and the return time of all vehicles to the depot. The first part of the objective function minimizes the completion time of all batches by all pickers in pickup process. The second part of the objective function minimizes the cost of the purchasing of all unavailable products from known products vendors. The third part of the objective function minimizes the return time of all vehicles to depot in delivery process. Constraints (3) and (4) assign two types of available and unavailable products of the orders to the batches. These constraints guarantee that each of the unavailable and available products in each order will be only assigned to one batch of  $\Gamma$  and  $\Phi$ , respectively. Constraints (5) and (6) guarantee that for each of the batches of  $\Gamma$  and  $\Phi$ , respectively, the total number of unavailable products and the available products of allocated orders to it should be less than the batch capacity. Constraints (7) and (8) ensure that each of the batches of  $\Gamma$  and  $\Phi$  should be assigned to only one picker. Constraints (9) and (10) state that each slot is only visited once for each of the batches  $\Gamma$  and  $\Phi$ . Constraints (11) and (12) provide a linkage between connectivity and visiting slots. Constraint (13) represents connectivity constraint. Constraint (14) ensures that only activated batches of  $\Gamma$  can visit slots. Constraints (15) and (16) calculate the minimum and the maximum purchased amount per unavailable product in total orders. Constraints (17) and (18) provide a linkage between connectivity and visiting slots. Constraint (19) represents connectivity constraint. Constraint (20) ensures that only activated batches of  $\Phi$  can visit slots. Constraints (21) and (22) ensure that only activated batches are assigned to the pickers. Constraint (23) signifies the start time of each batch  $\Gamma$  by each picker. This time is the sum of the unavailable products purchasing time and the maximum arrival time of the orders allocated to the batch. Constraint (24) signifies the start time of each batch  $\Phi$  by each picker. The mentioned time is the maximum arrival time of the orders allocated to the batch. Constraint (25) determines that the travel time of each batch is the sum of travel times of all visited slots by each picker. Constraint (26) states that the pick time of each batch is equal to the pick times of all visited slots by each picker. Constraint (27) specifies that the service time of each batch by each picker is the sum of the setup time, the pick time and the travel time. Constraint (28) calculates the completion time of each batch by each picker, which is the sum of the start time and the service time. Constraints (29) and (30) are subtour elimination constraints for the routing of the batches  $\Gamma$ . Constraints (31) and (32) are subtour elimination constraints for the routing of the batches  $\Phi$ . Constraints (33) and (34) calculate the number of unavailable products and available products of each order, respectively. Constraint (35) determines the scanning-packing time of each order, which contains unavailable products. Constraint (36) determines the scanning-packing time of each order, which contains available products. Constraints (37) and (38) state that each order containing unavailable products should only assigned to one vehicle  $\Lambda$ , so that the total orders allocated to it must be less than the vehicle capacity. Constraints (39) and (40) signify that each order containing available products should only assigned to one vehicle  $\Delta$ , so that the total orders allocated to it must be less than the vehicle capacity. Constraints (41) and (42) calculate the departure time of each vehicle of  $\Lambda$  and  $\Delta$ , respectively. These times are the sum of the maximum completion time in the pickup process and the sum of the scanning-packing times of all allocated orders to each vehicle. Constraints (43) and (44) specify the return times of each vehicles of  $\Lambda$  and  $\Delta$ , respectively, that is the sum of the departure times of the vehicles and the round trip-time from depot to the community of customers. Constraint (45) determines the type of decision variables. Since constraints (23) to (28) and (41) and (42) are non-linear, they could be linearized by defining axillary decision variables  $\bar{U}_b, \bar{A}_b, \bar{x}_{ijbp}^b, \bar{z}_{ibp}, \bar{\delta}_{bp}, \bar{s}_{bp}, \bar{c}_{bp}, \bar{t}_{bp}, \bar{d}$  and  $\bar{e}$ , and substitute and adding constraints (46) to (75).

$$\mathfrak{G}_{bp} \geq \bar{U}_b + \sum_{p=1}^U \sum_{o=1}^O (\mathcal{R}_p + \mathcal{C}_p) \psi_{ob}^p \quad \forall b \in \Gamma; p \in P \quad (46)$$

$$\bar{U}_b \geq \sum_{p=1}^U \sum_{o=1}^O t_o \psi_{ob}^p \quad \forall b \in \Gamma \quad (47)$$

$$\mathfrak{G}_{bp} \geq \bar{A}_b \quad \forall b \in \Phi; p \in P \quad (48)$$

$$\bar{A}_b \geq \sum_{p=1}^A \sum_{o=1}^O t_o \psi_{ob}^p \quad \forall b \in \Phi \quad (49)$$

$$\mathfrak{X}_{bp} \geq \sum_{i=0}^S \sum_{j=0}^S t_{ij} \bar{x}_{ijbp}^b \quad \forall b \in \mathbb{B}; p \in P \quad (50)$$

$$\bar{x}_{ijbp}^b \leq x_{ij}^b \quad \forall b \in \mathbb{B}; p \in P; i, j \in S \quad (51)$$

$$\bar{x}_{ijbp}^b \leq z_{bp} \quad \forall b \in \mathbb{B}; p \in P; i, j \in S \quad (52)$$

$$\bar{x}_{ijbp}^b \geq x_{ij}^b + z_{bp} - 1 \quad \forall b \in \mathbb{B}; p \in P; i, j \in S \quad (53)$$

$$\mathbb{S}\mathbb{P}_{bp} = \sum_{i=1}^S \infty_i \bar{z}_{ibp} \quad \forall b \in \mathbb{B}; p \in P \quad (54)$$

$$\bar{z}_{ibp} \leq \alpha_{bi} \quad \forall b \in \mathbb{B}; p \in P; i \in S \quad (55)$$

$$\bar{z}_{ibp} \leq z_{bp} \quad \forall b \in \mathbb{B}; p \in P; i \in S \quad (56)$$

$$\bar{z}_{ibp} \geq \alpha_{bi} + z_{bp} - 1 \quad \forall b \in \mathbb{B}; p \in P; i \in S \quad (57)$$

$$\mathfrak{f}_{bp} = (\bar{t}_{bp} z_{bp} + \bar{\delta}_{bp} + \bar{s}_{bp}) \quad \forall b \in \mathbb{B}; p \in P \quad (58)$$

$$\bar{\delta}_{bp} \leq \mathfrak{X}_{bp} \quad \forall b \in \mathbb{B}; p \in P \quad (59)$$

$$\bar{\delta}_{bp} \leq M z_{bp} \quad \forall b \in \mathbb{B}; p \in P \quad (60)$$

$$\bar{\delta}_{bp} \geq \mathfrak{X}_{bp} - M(1 - z_{bp}) \quad \forall b \in \mathbb{B}; p \in P \quad (61)$$

$$\bar{s}_{bp} \leq \mathbb{S}\mathbb{P}_{bp} \quad \forall b \in \mathbb{B}; p \in P \quad (62)$$

$$\bar{s}_{bp} \leq M z_{bp} \quad \forall b \in \mathbb{B}; p \in P \quad (63)$$

$$\bar{s}_{bp} \geq \mathbb{S}\mathbb{P}_{bp} - M(1 - z_{bp}) \quad \forall b \in \mathbb{B}; p \in P \quad (64)$$

$$\mathfrak{C}_{bp} = (\bar{c}_{bp} + \bar{t}_{bp}) \quad \forall b \in \mathbb{B}; p \in P \quad (65)$$

$$\bar{c}_{bp} \leq \mathfrak{G}_{bp} \quad \forall b \in \mathbb{B}; p \in P \quad (66)$$

$$\bar{c}_{bp} \leq M z_{bp} \quad \forall b \in \mathbb{B}; p \in P \quad (67)$$

$$\bar{c}_{bp} \geq \mathfrak{G}_{bp} - M(1 - z_{bp}) \quad \forall b \in \mathbb{B}; p \in P \quad (68)$$

$$\bar{t}_{bp} \leq \mathfrak{f}_{bp} \quad \forall b \in \mathbb{B}; p \in P \quad (69)$$

$$\bar{t}_{bp} \leq M z_{bp} \quad \forall b \in \mathbb{B}; p \in P \quad (70)$$

$$\bar{t}_{bp} \geq \mathfrak{f}_{bp} - M(1 - z_{bp}) \quad \forall b \in \mathbb{B}; p \in P \quad (71)$$

$$\mathcal{D}_v = (\bar{d} + \sum_{o=1}^O \mathbb{1}_{ov} \Psi_o) \quad \forall v \in \Lambda \quad (72)$$

$$\bar{d} \geq \sum_{b=1}^{\Gamma} \sum_{p=1}^P \mathbb{C}_{bp} \quad \forall v \in \Lambda \quad (73)$$

$$\mathcal{D}_v = (\bar{e} + \sum_{o=1}^O \mathbb{1}_{ov} \Omega_o) \quad \forall v \in \Delta \quad (74)$$

$$\bar{e} \geq \sum_{b=1}^{\Phi} \sum_{p=1}^P \mathbb{C}_{bp} \quad \forall v \in \Delta \quad (75)$$

#### IV. HEURISTIC ALGORITHMS

In this section, four effective heuristic algorithms are presented to solve the proposed model, including order batching based on two types of products, picker routing, assigning orders to the vehicles, and integrated order picking and delivery heuristic. In fact, the purpose of this section is to propose an effective and fast heuristic approach to solve the presented integrated model.

For order batching problems, constructive heuristic solution approaches are usually divided into three groups: seed algorithms, saving algorithms and priority-rule based algorithms. The seed algorithms include two steps: selecting seed orders and assigning the other orders to the seed orders. There are various rules for selecting the seed orders and assigning other orders. The saving algorithms calculate the saving of each pair of orders and then merge the orders based on particular rules. The priority-rule based algorithms include two phases of assigning priorities to the orders and allocating orders to the batches. There are several rules for determining priorities to the orders, one of which is FCFS (First-Come-First-Serve) rule. This rule assigns the priorities to the orders according to their arrival times. There are two different approaches for assigning orders to the batches: Next-Fit Rule and First-Fit Rule or Best-Fit Rule. In the first approach, if the batch capacity is sufficient, only that batch is activated. But in the second approach, batches can be simultaneously activated for allocation (Henn et al., 2012). After determining the batches of the orders, the pickers' path for each batch should be specified. An effective picker routing can reduce the travel time as well as the picking time of the batches. Therefore, an effective heuristic solution approach of picker routing should be combined with the order batching heuristic approach. The picker routing problem can be considered as a TSP problem. Order batching and TSP problems are both NP-hard and there are many solution approaches for each of these problems. But to solve the presented integrated problem in this research, quick and consecutive solutions are needed. Algorithms that can create fast and acceptable solutions in a reasonable and short solution time can be suitable solution approaches for our research. Therefore, in this study, the heuristic approaches are used to solve the above integrated model. Algorithms based on priority-rule based are applied in our research due to less computational complexity. In order to respond quickly to the received orders, we applied the FCFS rule. Also, in order to create the optimum number of batches, the Next-Fit Rule has been used. Finally, we present an order batching heuristic algorithm based on the two types of the products in the orders. Among the constructive heuristic solution approaches for the TSP problem, the nearest neighbor method is used due to its less computational complexity. In this study, it is assumed that orders are delivered to each customer twice at most. So, the existence of two types of products in the orders is an important and effective factor in the process of assigning orders to the delivery vehicles. For this purpose, we have presented a heuristic algorithm for assigning orders to the vehicles. Finally, for the two integrated processes of order picking and delivery, considering two types of products and regarding the two mentioned strategies, a heuristic approach is proposed for this research.

#### *F. Order batching, routing and delivery heuristics*

The order batching heuristic algorithm aims to classify the orders based on the two types of unavailable and available products. All batches can be divided into two categories: batches for unavailable products and batches for available products. First, according to the FCFS rule, the priorities are assigned to the products of the orders. Then, the first unavailable product from the first order is assigned to the first batch of  $\Gamma$ . Also, the first available product from the first order is assigned to the first batch of  $\Phi$ . The next unavailable products and also the next available products of the orders are assigned to the same batch, respectively, if there is batch capacity. Otherwise, the next batch will be activated for

unavailable products and available products. This process is repeated to allocate all types of the products of the orders to the batches. The pseudo-code of the proposed order batching heuristic algorithm is provided in Algorithm 1. The nearest neighbor heuristic algorithm is used to determine the sequence of visiting slots and calculate the travel time of the created batches. First, after selecting an arbitrary slot, the closest unselected slot to the specified slot is determined. Then this process continues until all the unselected slots in the batch are selected. Finally, after meeting the last slot, the initial slot is selected again. The structure of the above approach is explained in the pseudo-code of Algorithm 2. The assigning orders heuristic algorithm aims to assign orders to the vehicles according to the all types of products. The first order including the unavailable products and the available products with the minimum arrival time and the highest priority are assigned to  $\Lambda$  and  $\Delta$  vehicles, respectively. Subsequent orders will be assigned to the same vehicles if there is vehicle capacity. Otherwise, the next vehicles from each group of  $\Lambda$  and  $\Delta$  vehicles are activated. This process continues until all orders are assigned to the vehicles. The pseudo-code of the proposed assigning orders heuristic algorithm is provided in Algorithm 3.

---

**Algorithm 1. Batching orders**

---

```

0  set  $O, U, A, \mathbb{P}, \Gamma, \Phi, \mathbb{B}$ 
1  assign the priorities to all products of all orders according to FCFS Rule
2  sort all products of all orders according to non-ascending priorities
3  assign the first product  $p \in U$  of the first order to the first batch  $\Gamma$  (active batch)
4  assign the first product  $p \in A$  of the first order to the first batch  $\Phi$  (active batch)
5  while  $O \neq \emptyset$  do
6      if number of product  $p \in U$  of order  $o \leq$  capacity of active batch  $\Gamma$ 
7          assign  $p \in U$  to activate batch  $\Gamma$ 
8      else
9          select new batch from  $\Gamma$ 
10         assign  $p \in U$  to new batch
11     endif
12     if number of product  $p \in A$  of order  $o \leq$  capacity of active batch  $\Phi$ 
13         assign  $p \in A$  to activate batch  $\Phi$ 
14     else
15         select new batch from  $\Phi$ 
16         assign  $p \in A$  to new batch
17     endif
18 endwhile

```

---



---

**Algorithm 2. Nearest neighbor**

---

```

0  set  $S$ 
1  select an arbitrary slot  $i \in S$  (depot:0,  $i \leftarrow 0$ )
2  set  $j = i$  and  $S \setminus \{i\}$ 
3  while  $S \neq \emptyset$ 
4      let  $i \in S$ 
5      calculate  $t_{ji} = \min \{t_{ji} | i \in \mathcal{M}\}$ 
6      connect  $j$  to  $i$ 
7      set  $S = S \setminus \{i\}$  and  $j = i$ 
8  endwhile
9  connect  $j$  to the slot  $i$  selected in line 1
10 return a batch tour
11 return  $\mathfrak{X}_{bp}$ 

```

---

**Algorithm 3. Assigning orders to the vehicles**

---

```

0  set  $O, \Lambda, \Delta, \mathbb{V}, p_o, q_o$ 
1  assign the first order to the first vehicle  $\Lambda$  (active vehicle) according to their priorities
2  assign the first order to the first vehicle  $\Delta$  (active vehicle) according to their priorities
3  while  $O \neq \emptyset$  do
4      if  $p_o \leq$  capacity of active vehicle  $\Lambda$ 
5          assign order  $o$  to  $\Lambda$ 
6      else
7          select new vehicle from  $\Lambda$ 
8          assign order  $o$  to new vehicle
9      endif
10     if  $q_o \leq$  capacity of active vehicle  $\Delta$ 
11         assign order  $o$  to  $\Delta$ 
12     else
13         select new vehicle from  $\Delta$ 
14         assign order  $o$  to new vehicle
15     endif
16 endwhile

```

---

**G. Integrated order picking and delivery heuristic**

This section presents a novel heuristic algorithm to solve our problem including the integrated order picking and delivery with considering two strategies of overbooking and delivery postponed. At first, the proposed algorithm aims to assign the products of the orders to the batches according to Algorithm 1. In fact, the created batches are divided into two groups including unavailable products and available products. Then, the number of required unavailable products is calculated. The created batches from the two groups of  $\Gamma$  and  $\Phi$  are assigned to the pickers. The pickers' travel time is calculated by Algorithm 2, and the completion time of all batches by all pickers is calculated. In order to deliver the orders to the customers, Algorithm 3 is applied to allocate orders to the vehicles. Activated vehicles are divided into two groups, including unavailable products and available products. The scanning-packing time is calculated for all orders and finally, the times of departure and return of the vehicles is determined. The pseudo-code of the proposed integrated order picking and delivery heuristic algorithm is provided in Algorithm 4.

**Algorithm 4. Integrated order picking and delivery**

---

```

0  set  $O, U, A, \mathbb{P}, \Gamma, \Phi, \mathbb{B}, P, S, \Lambda, \Delta, \mathbb{V}$ 
1  calculate a set of batches  $\mathbb{B}$  according to Algorithm 1
2   $\mathbb{B}_1 \leftarrow$  a set of batches  $\Gamma$ 
3   $\mathbb{B}_2 \leftarrow$  a set of batches  $\Phi$ 
4  calculate Quantity purchased of product  $p$  ( $Q_p$ ) by Eq. (15,16)
5   $z_2 \leftarrow \sum_{p \in U} \mathbb{Z}_p Q_p$ 
6  set current batch  $a$  to the first batch  $\mathbb{B}_1$  and assign  $a$  to a picker  $p$ 
7  if  $\mathbb{B}_1 = \emptyset$ , go to line 11; otherwise, go to next step
8  take the batch  $a$  as the  $a$ th batch and calculate start time ( $\mathcal{S}_{bp}$ ) by Eq. (23)
9  calculate travel time ( $\mathcal{T}_{bp}$ ) according to Algorithm 2
10 calculate pick time ( $\mathcal{P}_{bp}$ ) by Eq. (26), service time ( $\mathcal{f}_{bp}$ ) by Eq. (27) and completion time ( $\mathcal{C}_{bp}$ ) by Eq.
(28),  $a = a + 1$  and go to line 6
11 set current batch  $b$  to the first batch  $\mathbb{B}_2$  and assign  $b$  to a picker  $p$ 
12 if  $\mathbb{B}_2 = \emptyset$ , go to line 31; otherwise, go to next step
13 take the batch  $b$  as the  $b$ th batch and calculate start time ( $\mathcal{S}_{bp}$ ) by Eq. (24)
14 calculate travel time ( $\mathcal{T}_{bp}$ ) according to Algorithm 2
15 calculate pick time ( $\mathcal{P}_{bp}$ ) Eq. (26), service time ( $\mathcal{f}_{bp}$ ) Eq. (27) and completion time ( $\mathcal{C}_{bp}$ ) Eq.
(28),  $b=b+1$  and go to line 11
16 endif
17 endif

```

---

---

|    |  |
|----|--|
| 18 | $z_1 \leftarrow \sum_{b \in \mathbb{B}} \sum_{p \in P} \mathbb{C}_{bp}$  |
| 19 | calculate a set of vehicles $\mathfrak{B}$ according to Algorithm 3  |
| 20 | $\mathfrak{B}_1 \leftarrow$ a set of vehicles $\Lambda$  |
| 21 | $\mathfrak{B}_2 \leftarrow$ a set of vehicles $\Delta$   |
| 22 | calculate number of the products of $U$ and $A$ ( $\mathbb{H}1_o, \mathbb{H}2_o$ ) by Eq. (33,34)  |
| 23 | $\Psi_o \leftarrow \mathbb{H}1_o(t_1 + t_2)$   |
| 24 | $\Omega_o \leftarrow \mathbb{H}2_o(t_1 + t_2)$   |
| 25 | set current vehicle $c$ to the first vehicle $\mathfrak{B}_1$  |
| 26 | take the vehicle $c$ as the $c$ th vehicle and calculate start time from depot ( $\mathcal{D}_v$ ) by Eq. (41) and return time ( $\mathbb{R}_v$ ), $c=c+1$ and go to line 25 |
| 27 | set current vehicle $d$ to the first vehicle $\mathfrak{B}_2$  |
| 28 | take the vehicle $d$ as the $d$ th vehicle and calculate start time from depot ( $\mathcal{D}_v$ ) by Eq. (41) and return time ( $\mathbb{R}_v$ ), $d=d+1$ and go to line 27 |
| 29 | $z_3 \leftarrow \sum_{v \in \mathbb{V}} \mathbb{R}_v$  |
| 30 | return $z_1 + z_2 + z_3$   |
| 31 | No activated batches exists, stop the process  |

---

## V. COMPUTATIONAL EXPERIMENTS

### H. Numerical results

This section presents the numerical results to illustrate the validation and effectiveness of the proposed mathematical models and solution approaches. For this purpose, 30 test problems are designed, where Table II represents the specifications of all test problems. Also, the source of random generation values for parameters is provided in Table III. The GAMS software and MATLAB R2015b are used to code models and solution approaches, respectively, where all of them are executed on a 2.13 GHz Intel Core i3 processor notebook with 4GB of RAM memory. The summary of the obtained results is provided in Table IV in terms of objective function values (OFVs), CPU times, and the GAPS (%) between the OFVs of GAMS and heuristic algorithms. Notably, in order to obtain optimal solutions via GAMS software, CPU time is restricted to 11640s (three hours and fourteen minutes). As can be seen in these tables, the proposed heuristic algorithms have obtained high-quality solutions in a reasonable time compared to GAMS software. The computational results in Table IV shows that as the dimensions of the test problems increased (test problem 16), GAMS did not provide the optimal solution at this restricted time (11640s). Additionally, in all test problems, the maximum GAP is up to 8.14%, and the average GAPS is 1.87%. Moreover, for better understanding, one designed test problem has been shown on the graph in Fig. 3.

Table II. The specifications of all test problems

|             | Problem No. | No. of slots of the shelves | No. of orders | No. of unavailable products(U) | No. of unavailable products(A) | No. of all products | No. of batches for products U | No. of batches for products A | No. of all batches | No. of pickers | No. of vehicles for products U | No. of vehicles for products A | No. of all vehicles |
|-------------|-------------|-----------------------------|---------------|--------------------------------|--------------------------------|---------------------|-------------------------------|-------------------------------|--------------------|----------------|--------------------------------|--------------------------------|---------------------|
| Small-sized | 1           | 27                          | 10            | 5                              | 5                              | 10                  | 5                             | 5                             | 10                 | 10             | 5                              | 5                              | 10                  |
|             | 2           | 27                          | 10            | 5                              | 5                              | 10                  | 5                             | 5                             | 10                 | 10             | 5                              | 5                              | 10                  |
|             | 3           | 27                          | 10            | 5                              | 5                              | 10                  | 5                             | 5                             | 10                 | 10             | 5                              | 5                              | 10                  |
|             | 4           | 27                          | 10            | 5                              | 5                              | 10                  | 5                             | 5                             | 10                 | 10             | 5                              | 5                              | 10                  |
|             | 5           | 27                          | 10            | 5                              | 5                              | 10                  | 5                             | 5                             | 10                 | 10             | 5                              | 5                              | 10                  |
|             | 6           | 27                          | 12            | 5                              | 5                              | 10                  | 6                             | 6                             | 12                 | 12             | 6                              | 6                              | 12                  |
|             | 7           | 27                          | 12            | 5                              | 5                              | 10                  | 6                             | 6                             | 12                 | 12             | 6                              | 6                              | 12                  |
|             | 8           | 27                          | 12            | 5                              | 5                              | 10                  | 6                             | 6                             | 12                 | 12             | 6                              | 6                              | 12                  |
|             | 9           | 27                          | 12            | 5                              | 5                              | 10                  | 6                             | 6                             | 12                 | 12             | 6                              | 6                              | 12                  |
|             | 10          | 27                          | 12            | 5                              | 5                              | 10                  | 6                             | 6                             | 12                 | 12             | 6                              | 6                              | 12                  |



|              |    |    |     |    |    |    |    |    |     |     |    |    |     |
|--------------|----|----|-----|----|----|----|----|----|-----|-----|----|----|-----|
| Medium-sized | 11 | 48 | 30  | 15 | 15 | 30 | 15 | 15 | 30  | 30  | 15 | 15 | 30  |
|              | 12 | 48 | 30  | 15 | 15 | 30 | 15 | 15 | 30  | 30  | 15 | 15 | 30  |
|              | 13 | 48 | 30  | 15 | 15 | 30 | 15 | 15 | 30  | 30  | 15 | 15 | 30  |
|              | 14 | 48 | 30  | 15 | 15 | 30 | 15 | 15 | 30  | 30  | 15 | 15 | 30  |
|              | 15 | 48 | 30  | 15 | 15 | 30 | 15 | 15 | 30  | 30  | 15 | 15 | 30  |
|              | 16 | 48 | 42  | 15 | 15 | 30 | 21 | 21 | 42  | 42  | 21 | 21 | 42  |
|              | 17 | 48 | 42  | 15 | 15 | 30 | 21 | 21 | 42  | 42  | 21 | 21 | 42  |
|              | 18 | 48 | 42  | 15 | 15 | 30 | 21 | 21 | 42  | 42  | 21 | 21 | 42  |
|              | 19 | 48 | 42  | 15 | 15 | 30 | 21 | 21 | 42  | 42  | 21 | 21 | 42  |
|              | 20 | 48 | 42  | 15 | 15 | 30 | 21 | 21 | 42  | 42  | 21 | 21 | 42  |
| Large-sized  | 21 | 75 | 70  | 20 | 20 | 40 | 35 | 35 | 70  | 70  | 35 | 35 | 70  |
|              | 22 | 75 | 70  | 20 | 20 | 40 | 35 | 35 | 70  | 70  | 35 | 35 | 70  |
|              | 23 | 75 | 70  | 20 | 20 | 40 | 35 | 35 | 70  | 70  | 35 | 35 | 70  |
|              | 24 | 75 | 70  | 20 | 20 | 40 | 35 | 35 | 70  | 70  | 35 | 35 | 70  |
|              | 25 | 75 | 70  | 20 | 20 | 40 | 35 | 35 | 70  | 70  | 35 | 35 | 70  |
|              | 26 | 75 | 100 | 20 | 20 | 40 | 50 | 50 | 100 | 100 | 50 | 50 | 100 |
|              | 27 | 75 | 100 | 20 | 20 | 40 | 50 | 50 | 100 | 100 | 50 | 50 | 100 |
|              | 28 | 75 | 100 | 20 | 20 | 40 | 50 | 50 | 100 | 100 | 50 | 50 | 100 |
|              | 29 | 75 | 100 | 20 | 20 | 40 | 50 | 50 | 100 | 100 | 50 | 50 | 100 |
|              | 30 | 75 | 100 | 20 | 20 | 40 | 50 | 50 | 100 | 100 | 50 | 50 | 100 |

Table III. The sources of random generation values for parameters

| <i>Parameter</i> | <i>Corresponding random distribution</i> |
|------------------|--|
| $c_b$            | U[6,30]                                  |
| $t_o$            | U[1,110]                                 |
| $t_{b,p}$        | U[5,50]                                  |
| $d_{ij}$         | U[2,200]                                 |
| $v_h$            | U[2,20]                                  |
| $v_v$            | U[2,20]                                  |
| $t_{ij}$         | U[2,200]                                 |
| $\mathcal{R}_p$  | U[3,60]                                  |
| $\mathcal{C}_p$  | U[3,60]                                  |
| $n_{p,o}$        | U[5,40]                                  |
| $p_o$            | U[1,20]                                  |
| $q_o$            | U[1,20]                                  |
| $s_p$            | U[1,40]                                  |
| $\mathcal{D}_p$  | U[2,100]                                 |
| $\mathfrak{R}_p$ | U[50,100]                                |
| $\mathfrak{M}_p$ | U[50,100]                                |
| $t_1$            | U[2,220]                                 |
| $t_2$            | U[2,220]                                 |
| $\mathcal{C}_b$  | U[6,50]                                  |
| $\mathcal{Z}_p$  | U[2,40]                                  |
| $t$              | U[50,700]                                |
| $\infty_i$       | U[3,30]                                  |
| $w_1$            | U[0,1]                                   |
| $w_2$            | U[0,1]                                   |

Table IV. The summary of results for all test problems

| Problem No.  | <i>GAMS</i> |                    | <i>Heuristic method</i> |                    | <i>GAP %</i> |      |
|--------------|-------------|--------------------|-------------------------|--------------------|--------------|------|
|              | <i>OFVs</i> | <i>CPU time(s)</i> | <i>OFVs</i>             | <i>CPU time(s)</i> |              |      |
|              | <i>z</i>    | <i>z</i>           | <i>z</i>                | <i>z</i>           |              |      |
| Small-sized  | 1           | 719                | 0:16:43                 | 740                | 0:2:05       | 2.92 |
|              | 2           | 1842               | 0:16:43                 | 1860               | 0:2:05       | 0.97 |
|              | 3           | 2037               | 0:16:43                 | 2090               | 0:2:05       | 2.60 |
|              | 4           | 2240               | 0:16:43                 | 2290               | 0:2:00       | 2.23 |
|              | 5           | 2443               | 0:16:43                 | 2490               | 0:2:00       | 1.92 |
|              | 6           | 4810               | 0:16:44                 | 4811               | 0:2:14       | -    |
|              | 7           | 4562               | 0:16:44                 | 4884               | 0:2:14       | 7.05 |
|              | 8           | 4802               | 0:16:45                 | 4964               | 0:2:14       | 3.37 |
|              | 9           | 4897               | 0:16:43                 | 5154               | 0:2:00       | 5.20 |
|              | 10          | 5993               | 0:11:01                 | 6244               | 0:2:00       | 4.10 |
| Medium-sized | 11          | 17225              | 0:53:39                 | 18628              | 0:2:37       | 8.14 |
|              | 12          | 19625              | 0:53:58                 | 20528              | 0:2:38       | 4.60 |
|              | 13          | 20224              | 0:53:37                 | 21148              | 0:2:38       | 4.56 |
|              | 14          | 20824              | 0:53:46                 | 21748              | 0:2:38       | 4.43 |
|              | 15          | 21425              | 0:53:55                 | 22348              | 0:2:38       | 4.30 |
|              | 16          | -                  | 3:14:00                 | 33484              | 0:3:257      | -    |
|              | 17          | -                  | -                       | 37484              | 0:4:26       | -    |
|              | 18          | -                  | -                       | 37684              | 0:4:26       | -    |
|              | 19          | -                  | -                       | 38384              | 0:4:84       | -    |
|              | 20          | -                  | -                       | 39684              | 0:4:86       | -    |
| Large-sized  | 21          | -                  | -                       | 103076             | 0:6:76       | -    |
|              | 22          | -                  | -                       | 110076             | 0:6:80       | -    |
|              | 23          | -                  | -                       | 110356             | 0:6:80       | -    |
|              | 24          | -                  | -                       | 111756             | 0:6:90       | -    |
|              | 25          | -                  | -                       | 112036             | 0:6:99       | -    |
|              | 26          | -                  | -                       | 151616             | 0:10:01      | -    |
|              | 27          | -                  | -                       | 155616             | 0:10:01      | -    |
|              | 28          | -                  | -                       | 159616             | 0:11:10      | -    |
|              | 29          | -                  | -                       | 163616             | 0:11:10      | -    |
|              | 30          | -                  | -                       | 167616             | 0:11:21      | -    |
| Average      |             |                    |                         |                    | 1.87         |      |

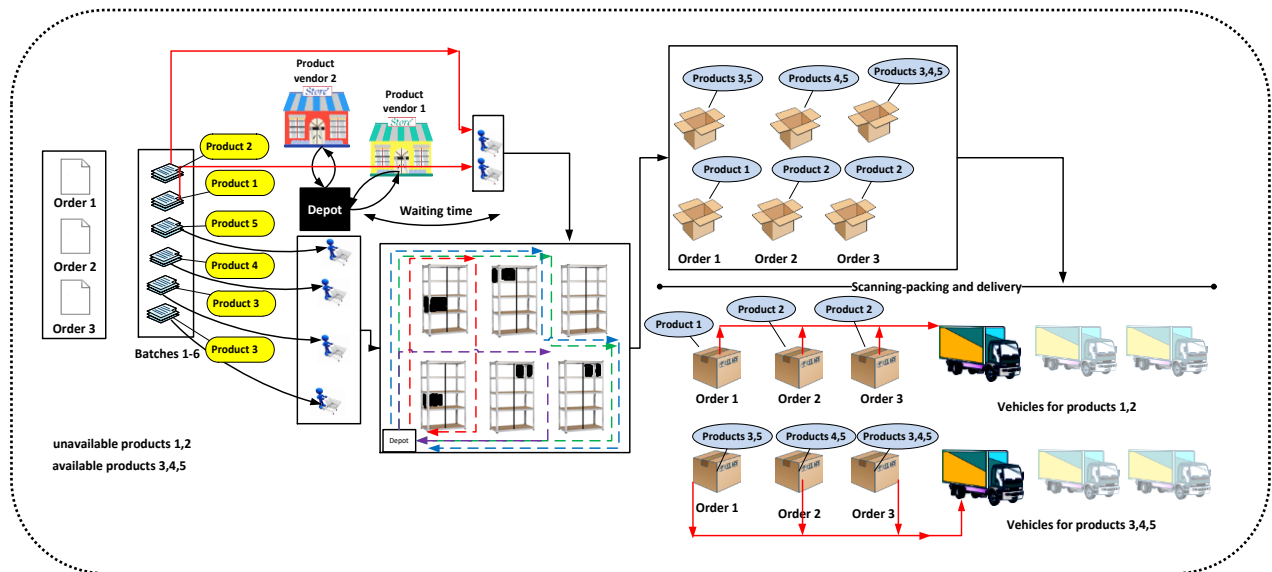

Fig 3. Schematization of the one designed test problem

### E. Sensitivity analysis

In order to examine the impacts of parameters on the objective function of the model, sensitivity analysis is performed. The results of this analysis are presented in Figs 4 to 8. The horizontal axis shows the percentage changes in parameters, and the vertical axis indicates the value of the objective function. The effects of changes in the batch capacity, arrival time of the orders, setup time of the batches, travel time between the slots, round-trip time from depot to the sellers' location, and the consumed time at the sellers' location on the objective function are shown in Fig. 4. This diagram clearly indicates that the reduction of the batch capacity increases the value of the objective function. Because by reducing this parameter, more batches are used, and for each batch, setup, travel and completion times are calculated as an effective part of the objective function. But with increase of this parameter, because fewer batches are activated, the value of the objective function is expected to decrease. But duo to the parameter of the number of products of the orders is constant, the value of the objective function does not change. Also, increasing or decreasing the other five parameters causes that the value of the objective function increases or decreases. With the increase of the arrival time of the orders, the start time of the batches increases as a part of the completion time of the batches. Also, by increasing the setup time and travel time, the service time of the batches increases. Increasing the parameters of the round-trip time from depot to the sellers' location and the consumed time at the sellers' location has a direct effect on the start time of the batches and also on the completion time of the batches. Fig. 5 demonstrates the effects of changes in the number of products of each order, the total number of unavailable products in each order, and the number of unavailable products through all orders on the objective function. Reducing the number of products of each order and the number of unavailable products through all orders causes the value of the objective function to decrease. Because by reducing these parameters, fewer batches are activated. Also, the less number of unavailable products are purchased and as, the number of delivery vehicles decreases, the return times of the vehicles are reduced. But by increasing these parameters, because the number of batches and batch capacity are constant, the process of order batching is not done. As a result, no batch is activated in the integrated process and the objective function becomes zero. By decreasing the total number of unavailable products in each order, the objective function remains fixed. This is duo to the vehicle capacity is constant, therefore, the activated delivery vehicles can leave the depot with less than its capacity. But by raising this parameter by greater than 400%, the objective function becomes zero. This is duo to the fact that the vehicle capacity has not been increased and there is no integrated picking and delivery process. The effects of changes in the overbooking percentage for purchasing unavailable product, vehicle capacity, and the purchase price per unavailable product on the objective function are depicted in Fig. 6. By raising the overbooking percentage, the objective function increases. Because the number of purchased products increases, therefore, the purchase cost increases as the second part of the objective function. But by reducing this parameter, the objective function decreases and then remains fixed. This is duo to the fact that the reduction of this parameter causes the minimum purchased number

of each unavailable product. Increasing or decreasing the vehicle capacity does not affect the objective function. Because the number of products in each order, the total number of unavailable products in each order, and the total number of available products in each order are constant. Increasing or decreasing the purchase price will increase or decrease the objective function, because this parameter has a direct effect on the purchase cost as the second part of the objective function. Fig. 7 indicates the effects of changes the total number of available products in each order, the allowed number of unavailable product on its shelf, and the allowed number of unavailable product in the warehouse on the objective function. By decreasing the total number of available products in each order, the objective function remains fixed. Because the vehicle capacity is constant and each vehicle can leave the depot with less than its capacity. But with the increase of this parameter, the objective function becomes zero. This is duo to that the vehicle capacity is still constant, as a result, no integrated order picking and delivery process is done. By increasing or decreasing the other two parameters, the objective function remains fixed, because the total number of products of the orders, the batch capacity and the vehicle capacity are constant. Therefore, there are no changes in the whole process of order batching and assigning orders to the vehicles. The effects of the changes in the scanning time of each product, the packing time of each product, the round-trip time from depot to the community of customers, and the required search and pick time on the objective function are shown in Fig. 8. As can be seen in this diagram, increasing or decreasing these parameters increases or decreases the objective function, because the scanning and packing times have an effect on the departure times of the vehicles. Also, the round-trip time is included as part of the return times of the vehicles. The required search and pick time is a part of the service time of the batches. Therefore, the service time as a part of the completion times of the batches has an important effect on the first part of the objective function.

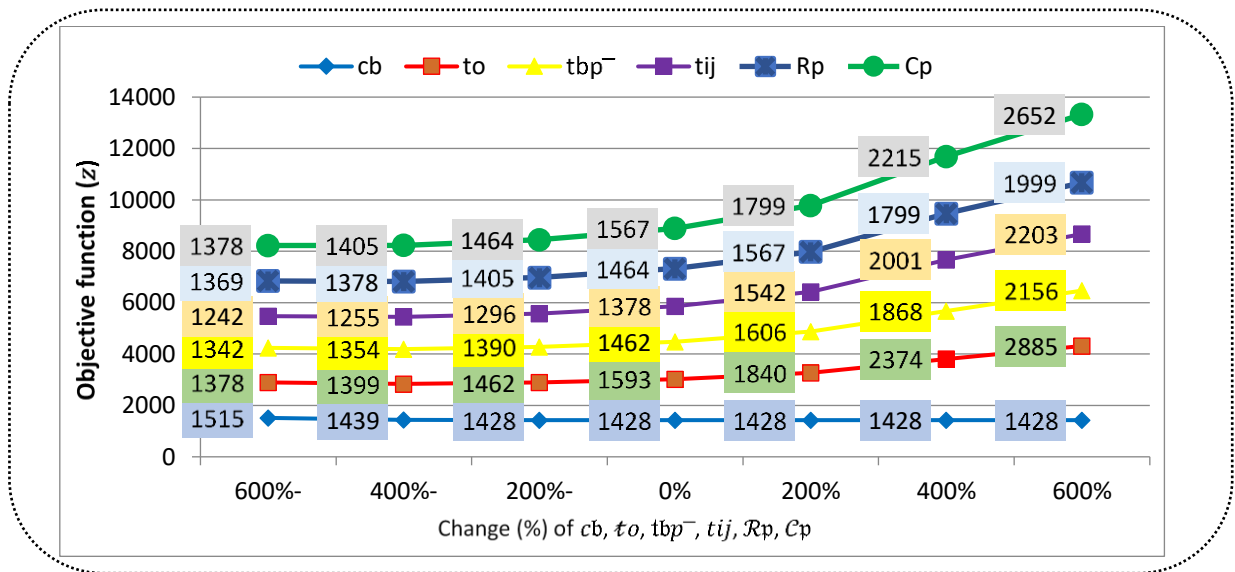

Fig 4. Effects of  $c_b, t_o, t_{bp}^-, t_{ij}, R_p, C_p$  on the objective function (z).

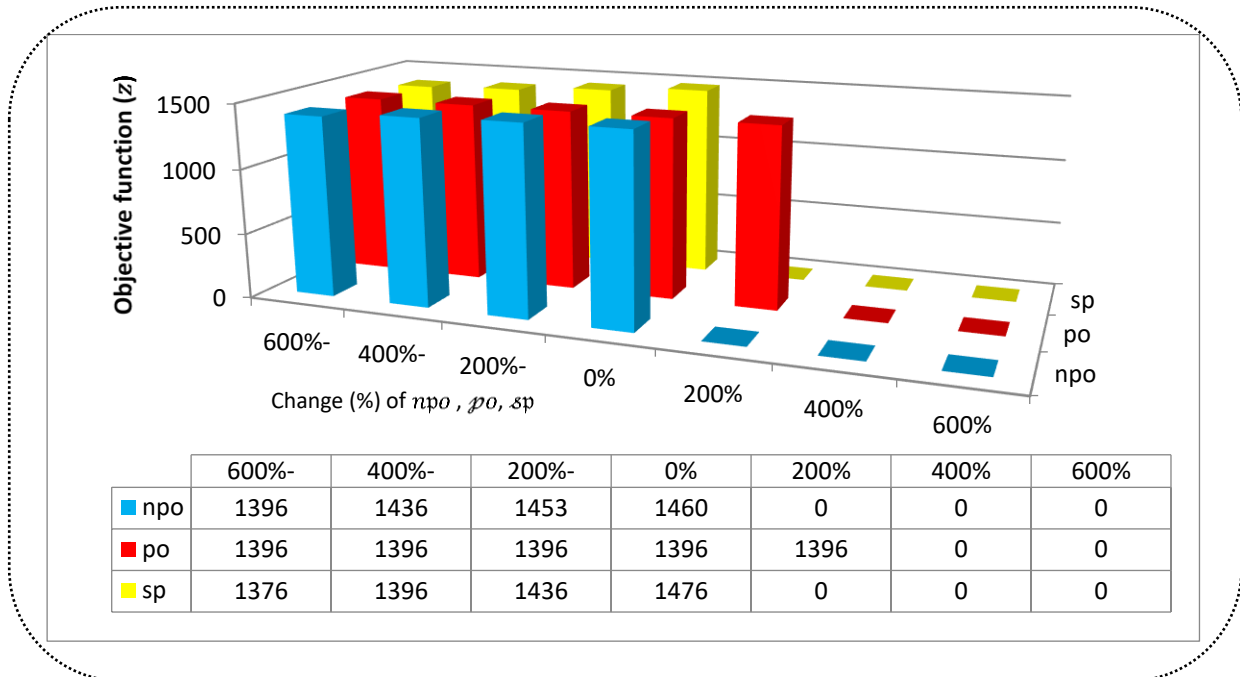

Fig 5. Effects of  $n_{po}$ ,  $po$ ,  $s_p$  on the objective function (z).

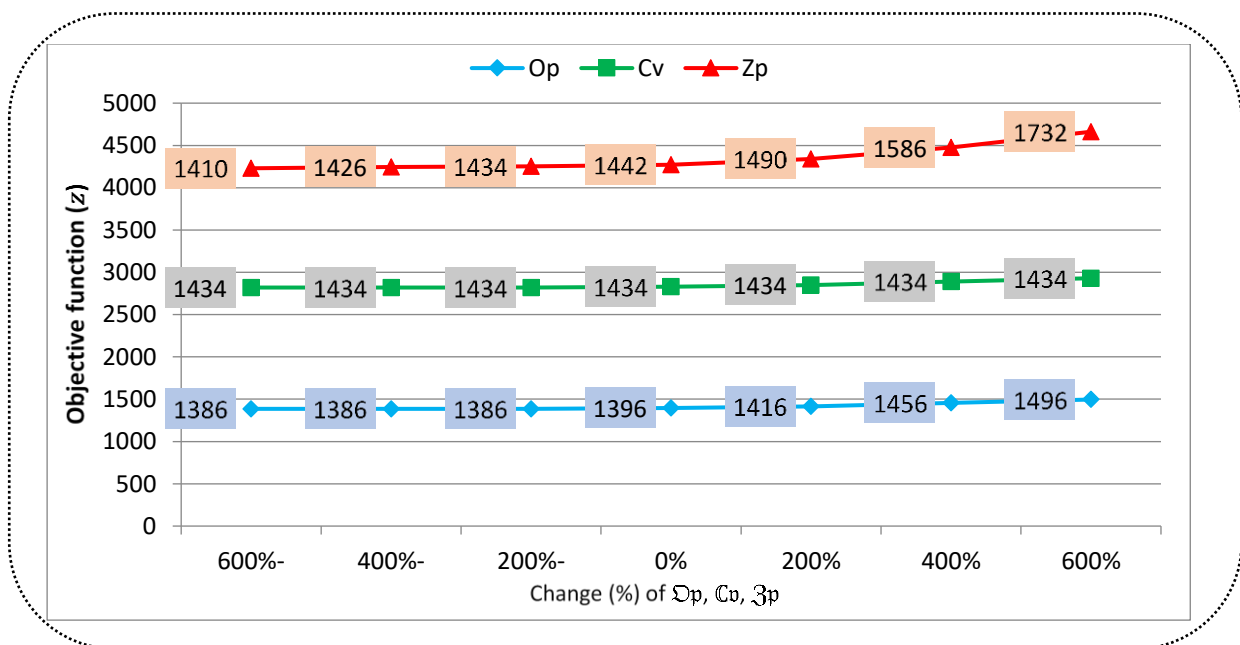

Fig 6. Effects of  $Op$ ,  $Cv$ ,  $Zp$  on the objective function (z).

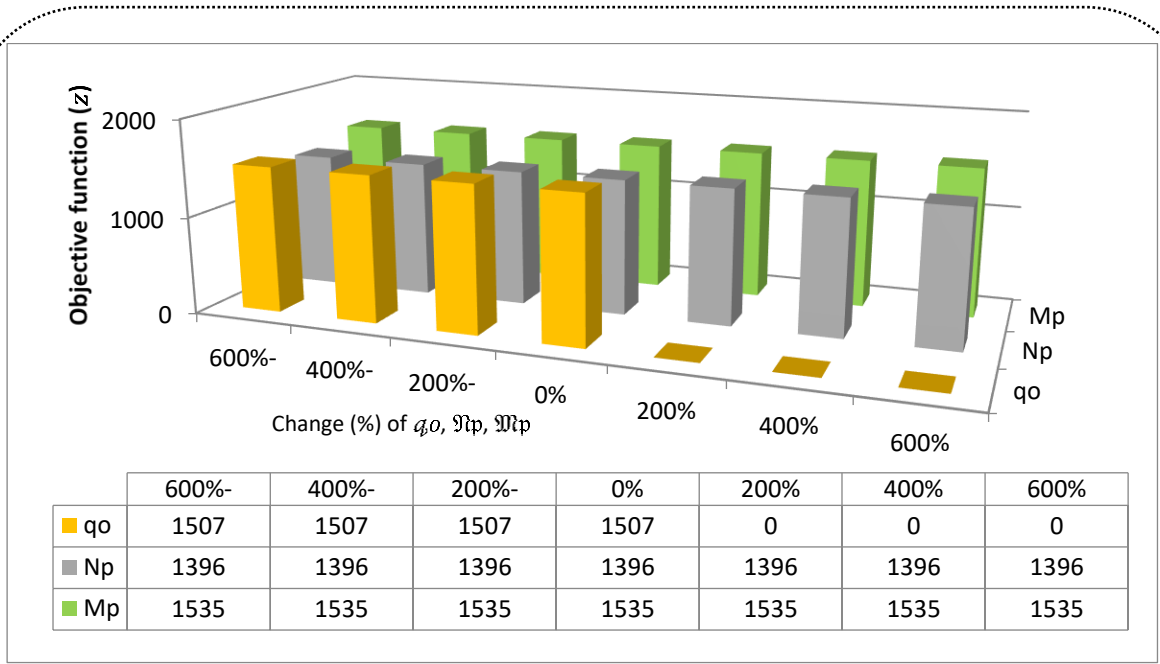

Fig 7. Effects of  $q_o$ ,  $N_p$ ,  $M_p$  on the objective function (z).

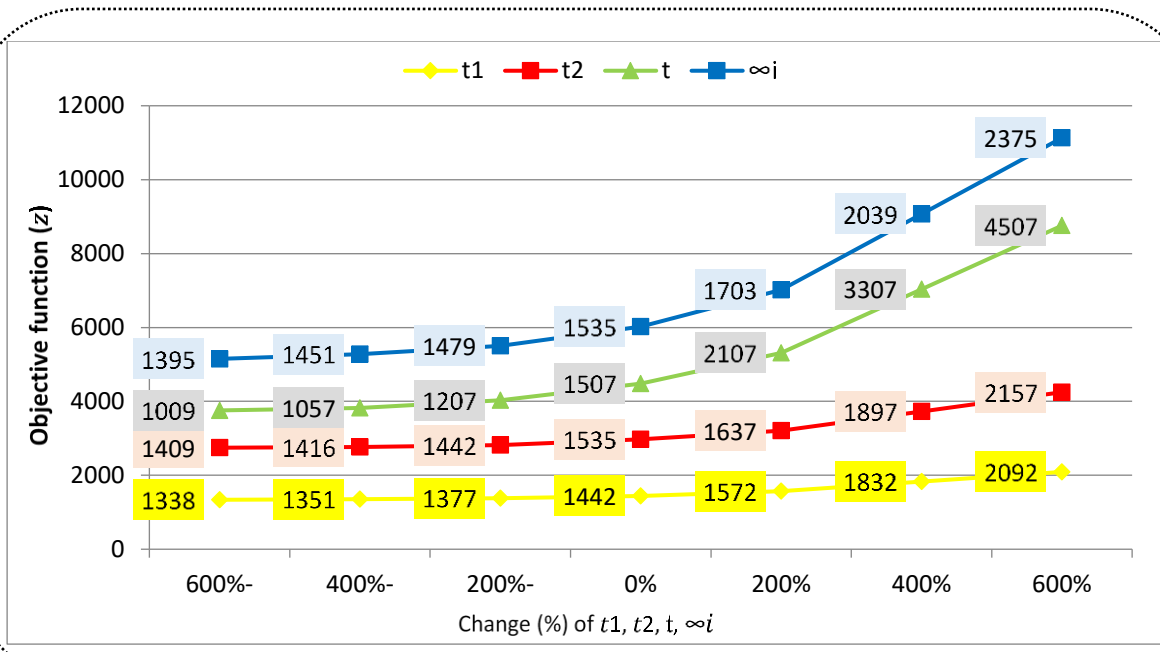

Fig 8. Effects of  $t_1$ ,  $t_2$ ,  $t$ ,  $\infty_i$  on the objective function (z).

### ***I. Managerial insights***

- According to the sensitivity analysis, the parameter  $\infty_i$  (the required search and pick time for each slot) plays an important role in the order picking process. The pickers carry out the process of searching and picking the products from each slot. Therefore, system efficiency can be improved by applying learning factor for human workforces (pickers).
- Based on above analysis, the parameter  $t$  (the round trip-time from depot to the community of customers) is also an effective factor in reducing the value of the objective function. As a result, regarding the optimal routing of delivery to customers will improve the efficiency of the system.

## **VI. CONCLUSION**

The integrated order picking and delivery problems in a warehouse where accepts customers' orders are studied in this paper. The warehouse policy regards to accept the orders which include unavailable products in addition to the available products. Thus, the concept of the overbooking strategy for purchasing the unavailable products and the delivery-delay allowed strategy for delayed deliveries are applied. As a result, this system involves a warehouse with two types of products: available and unavailable. In this regard, a new optimization model was proposed for this integrated process with considering overbooking and delivery-delay allowed strategies. The objective of this model was to minimize the cost of the completion time of all batches, the purchasing of the unavailable products and the return time of all vehicles to the depot. Each order is definitely divided into two parts. In this study, it is assumed that the delivery to each customer will be done in two times at most. Split orders must be identified (scanned) and packed during the consolidation process at the depot. Also, the travel time with considering the pickers' horizontal and vertical velocities in this multi-block 3D warehouse can be calculated between each two slots. Four new heuristic algorithms were proposed for this problem. A broad range of realistic characteristics was reflected in the proposed model, including order picking (joint order batching and picker routing), delivery problem, multi-block 3D warehouse, pickers' horizontal and vertical velocities, scanning-packing orders, two types of products, overbooking and delivery postponed strategies, in order to provide a practical action plan. The numerical experiments were conducted to clarify the validity and effectiveness of the proposed optimization model and heuristic algorithms. Computational results revealed that the proposed framework was able to significantly increase the efficiency and effectiveness of the investigated system. As future research, the concept of the learning effects for the pickers might be explored. This concept is beneficial for dealing with the order picking problem. Because travelling between aisles, searching and picking products from the shelves are repetitive and laborious activities which are influenced by the pickers' learning. Furthermore, considering the delivery routing in each customer zone is another future direction. In other words, the routing of each vehicle after leaving the depot and entering each customer zone can be mathematically formulated.

## **REFERENCES**

- Abad, H.K.E., Vahdani, B., Sharifi, M. and Etebari, F., 2018. A bi-objective model for pickup and delivery pollution-routing problem with integration and consolidation shipments in cross-docking system. *Journal of Cleaner Production*, 193, pp.784-801.
- Aerts, B., Cornelissens, T., & Sörensen, K. (2021). The joint order batching and picker routing problem: Modelled and solved as a clustered vehicle routing problem. *Computers & Operations Research*, 129, 105168.
- Agahgolnezhad Gerdrodbari, M., Harsej, F., Sadehpour, M., & Molani Aghdam, M. (2021). A green closed-loop supply chain for production and distribution of perishable products. *Journal of Quality Engineering and Production Optimization*, 6(1), 189-214.
- Briant, O., Cambazard, H., Cattaruzza, D., Catusse, N., Ladier, A. L., & Ogier, M. (2020). An efficient and general approach for the joint order batching and picker routing problem. *European Journal of Operational Research*, 285(2), 497-512.
- Boronoos, M., Torabi, S. A., & Mousazadeh, M. (2019). A Bi-objective Mathematical Model for Closed-loop Supply Chain Network Design Problem. *Journal of Quality Engineering and Production Optimization*, 4(1), 85-98.
- Cano, J. A., Correa-Espinal, A. A., & Gómez-Montoya, R. A. (2020). Mathematical programming modeling for joint order batching, sequencing and picker routing problems in manual order picking systems. *Journal of King Saud University-Engineering Sciences*, 32(3), 219-228.

- Gitinavard, H., Ghodspour, S. H., & Akbarpour Shirazi, M. (2019). A bi-objective multi-echelon supply chain model with Pareto optimal points evaluation for perishable products under uncertainty. *Scientia Iranica*, 26(5), 2952-2970.
- Gitinavard, H., Shirazi, M. A., & Zarandi, M. H. F. (2020). Sustainable feedstocks selection and renewable products allocation: A new hybrid adaptive utility-based consensus model. *Journal of environmental management*, 264, 110428.
- Gitinavard, H., Akbarpour Shirazi, M., & Fazel Zarandi, M. H. (2021). A possibilistic programming approach for biomass supply chain network design under hesitant fuzzy membership function estimation. *Scientia Iranica*.
- Henn, S. (2012). Algorithms for on-line order batching in an order picking warehouse. *Computers & Operations Research*, 39(11), 2549-2563.
- Henn, S., Koch, S., & Wäscher, G. (2012). Order batching in order picking warehouses: a survey of solution approaches. In *Warehousing in the global supply chain* (pp. 105-137). Springer, London.
- Jamshidi, R., Ghomi, S. F., & Karimi, B. (2012). Multi-objective green supply chain optimization with a new hybrid memetic algorithm using the Taguchi method. *Scientia Iranica*, 19(6), 1876-1886.
- Jiang, X., Zhou, Y., Zhang, Y., Sun, L., & Hu, X. (2018). Order batching and sequencing problem under the pick-and-sort strategy in online supermarkets. *Procedia computer science*, 126, 1985-1993.
- Kalantari Khalil Abad, A. R., & Pasandideh, S. H. R. (2020). A Multi-Objective Model for Green Closed-Loop Supply Chain Design by Handling Uncertainties in Effective Parameters. *Journal of Quality Engineering and Production Optimization*, 5(1), 221-242.
- Keshmiry Zadeh, K., Harsej, F., Sadeghpour, M., & Molani Aghdam, M. (2021). A multi-objective multi-echelon closed-loop supply chain with disruption in the centers. *Journal of Quality Engineering and Production Optimization*, 6(2), 31-58.
- Kulak, O., Sahin, Y., & Taner, M. E. (2012). Joint order batching and picker routing in single and multiple-cross-aisle warehouses using cluster-based tabu search algorithms. *Flexible services and manufacturing journal*, 24(1), 52-80.
- Masae, M., Glock, C. H., & Grosse, E. H. (2020). Order picker routing in warehouses: A systematic literature review. *International Journal of Production Economics*, 224, 107564.
- Mousavi, S.M., Vahdani, B., Tavakkoli-Moghaddam, R. and Hashemi, H., 2014. Location of cross-docking centers and vehicle routing scheduling under uncertainty: a fuzzy possibilistic–stochastic programming model. *Applied Mathematical Modelling*, 38(7-8), pp.2249-2264.
- Mousavi, S.M. and Vahdani, B., 2016. Cross-docking location selection in distribution systems: a new intuitionistic fuzzy hierarchical decision model. *International Journal of computational intelligence Systems*, 9(1), pp.91-109.
- Mousavi, S.M., Antuchevičienė, J., Zavadskas, E.K., Vahdani, B. and Hashemi, H., 2019. A new decision model for cross-docking center location in logistics networks under interval-valued intuitionistic fuzzy uncertainty. *Transport*, 34(1), pp.30-40.
- Mousavi, S.M. and Vahdani, B., 2017. A robust approach to multiple vehicle location-routing problems with time windows for optimization of cross-docking under uncertainty. *Journal of Intelligent & Fuzzy Systems*, 32(1), pp.49-62.
- Pansart, L., Catusse, N., & Cambazard, H. (2018). Exact algorithms for the order picking problem. *Computers & Operations Research*, 100, 117-127.
- Rabbani, M., Akbarian-Saravi, N., Ansari, M., & Musavi, M. (2020). A Bi-Objective Vehicle-Routing Problem for Optimization of a Bioenergy Supply Chain by Using NSGA-II Algorithm. *Journal of Quality Engineering and Production Optimization*, 5(1), 87-102.
- Scholz, A., Schubert, D., & Wäscher, G. (2017). Order picking with multiple pickers and due dates—simultaneous solution of order batching, batch assignment and sequencing, and picker routing problems. *European Journal of Operational Research*, 263(2), 461-478.
- Valle, C. A., Beasley, J. E., & Da Cunha, A. S. (2017). Optimally solving the joint order batching and picker routing problem. *European Journal of Operational Research*, 262(3), 817-834.
- Vahdani, B., Veysmoradi, D., Shekari, N. and Mousavi, S.M., 2018. Multi-objective, multi-period location-routing model to distribute relief after earthquake by considering emergency roadway repair. *Neural Computing and Applications*, 30(3), pp.835-854.
- Vahdani, B., Niaki, S.T.A. and Aslanzade, S., 2017. Production-inventory-routing coordination with capacity and time window constraints for perishable products: Heuristic and meta-heuristic algorithms. *Journal of cleaner production*, 161, pp.598-618.
- Vahdani, B., Tavakkoli-Moghaddam, R., Zandieh, M. and Razmi, J., 2012. Vehicle routing scheduling using an enhanced hybrid optimization approach. *Journal of Intelligent Manufacturing*, 23(3), pp.759-774.
- Vahdani, B., Soltani, M., Yazdani, M. and Mousavi, S.M., 2017. A three level joint location-inventory problem with correlated demand, shortages and periodic review system: Robust meta-heuristics. *Computers & Industrial Engineering*, 109, pp.113-129.
- Vahdani, B., Mansour, F., Soltani, M. and Veysmoradi, D., 2019. Bi-objective optimization for integrating quay crane and internal truck assignment with challenges of trucks sharing. *Knowledge-Based Systems*, 163, pp.675-692.
- Vahdani, B., 2019. Assignment and scheduling trucks in cross-docking system with energy consumption consideration and trucks queuing. *Journal of Cleaner Production*, 213, pp.21-41.



- Vaziri, S., Etebari, F. and Vahdani, B., 2019. Development and optimization of a horizontal carrier collaboration vehicle routing model with multi-commodity request allocation. *Journal of Cleaner Production*, 224, pp.492-505.
- Van Gils, T., Ramaekers, K., Braekers, K., Depaire, B., & Caris, A. (2018). Increasing order picking efficiency by integrating storage, batching, zone picking, and routing policy decisions. *International Journal of Production Economics*, 197, 243-261.
- Van Gils, T., Caris, A., Ramaekers, K., & Braekers, K. (2019). Formulating and solving the integrated batching, routing, and picker scheduling problem in a real-life spare parts warehouse. *European Journal of Operational Research*, 277(3), 814-830.
- Vakili, R., Akbarpour Shirazi, M., & Gitinavard, H. (2021). Multi-echelon green open-location-routing problem: A robust-based stochastic optimization approach. *Scientia Iranica*, 28(2), 985-1000.
- Won, J., & Olafsson\*, S. (2005). Joint order batching and order picking in warehouse operations. *International Journal of Production Research*, 43(7), 1427-1442.
- Weidinger, F. (2018). Picker routing in rectangular mixed shelves warehouses. *Computers & Operations Research*, 95, 139-150.
- Weidinger, F., Boysen, N., & Schneider, M. (2019). Picker routing in the mixed-shelves warehouses of e-commerce retailers. *European Journal of Operational Research*, 274(2), 501-515.
- Wang, T., Xing, Z., Hu, H., & Qu, X. (2019). Overbooking and delivery-delay-allowed strategies for container slot allocation. *Transportation Research Part E: Logistics and Transportation Review*, 122, 433-447.